

TRANSFLUID

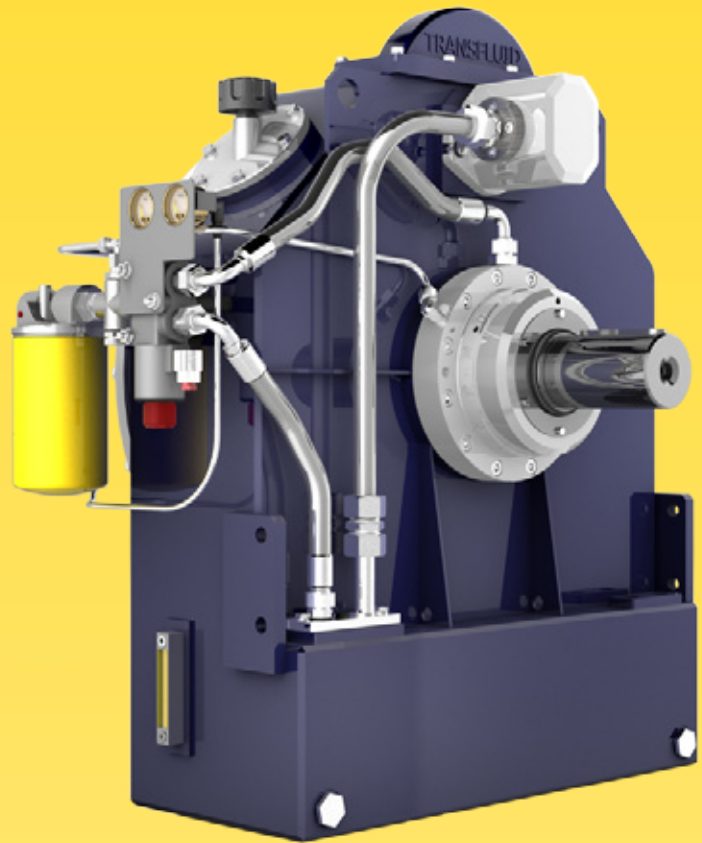

TRANSFLUID

trasmissioni industriali



drive with us

KPTO

DRAIN-TYPE FLUID COUPLING
for internal combustion engines

FLUID COUPLINGS KPTO SERIES for internal combustion engines

DESCRIPTION

The **KPTO** is a variable fill fluid coupling enclosed into a casing connected to the Diesel engine by means of a SAE housing. The **KPTO** has been designed to meet the market requirements for a unit combining the technical features of a conventional Power Take Off with the performances of a fluid coupling.

The **KPTO** has an integral feeding pump driven by the Diesel engine. A remote electrically operated ON-OFF solenoid valve allows the fluid coupling circuit to be fed when it is turned ON, while a rapid oil drain through calibrated orifices located on the periphery of the fluid coupling occurs when it is turned OFF. A forced bearing lubrication is always assured continuously.

The **KPTO** range is suitable for powers up to 1000 kW.

The engine flywheel is connected to the **KPTO** input by a highly torsionally flexible coupling. The output shaft can be connected to the driven machine by an elastic coupling, a cardan shaft or a pulley.

Standard accessories: oil feeding pump, oil filter with pressure and temperature gauges, ON-OFF electric valve, oil temperature and pressure switches, oil level indicators.

Optionals: water/oil heat exchanger or radiator, quick release valves, output pulley, elastic or superelastic alignment couplings.

WORKING SCHEME

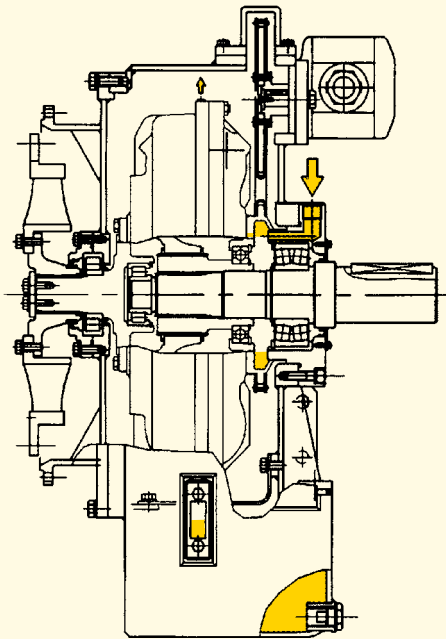

FEATURES

The KPTO drain type fluid coupling allows to disconnect the engine from the load granting the following advantages:

- unloaded engine warm up
- smooth start up, not belt slip
- shock and overload protection
- torsional vibration dampening
- high radial load capacity
- remote control by electric valve
- load positioning
- inexpensive and easy maintenance due to external mounting of the main accessories like oil filter, feeding pump, control valve
- longer life thanks to no friction linings to wear out.

APPLICATIONS

- mills, crushers, wood chippers, grinders, shredders
- belt conveyors
- reciprocating and centrifugal pumps, compressors
- marine propulsion, boat thrusters
- generators
- fans and blowers.

HYDRAULIC CIRCUIT

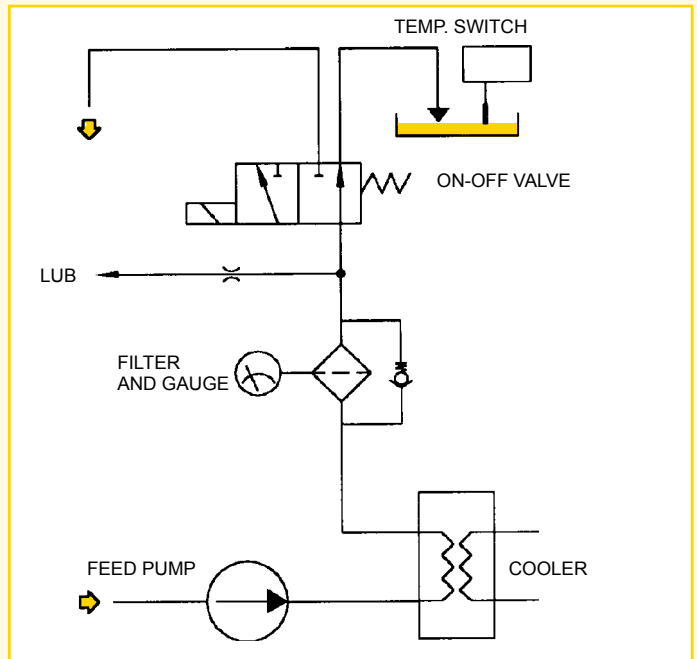

To calculate oil and water flow into heat exchanger, use following formulas:

$$\text{water (l/min)} = \frac{\text{power (kW)}}{50} \times 8$$

$$\text{oil (l/min)} = \frac{\text{power (kW)}}{50} \times 10$$

Above formulas are based upon following data:

Exchanger oil inlet = 110°C Exchanger oil outlet = 100°C
Exchanger water inlet = 85°C Exchanger water outlet = 90°C

Engine cooling water can be used.

rpm	Size	ENGINE POWER (kW)				
		15	19	21	24	27
1000		-	70	100	150	220
1200		-	90	150	220	300
1500		65	160	230	315	570
1800		85	275	400	545	1000
2200		155	330	470	650	-
2600		200	400	-	-	-

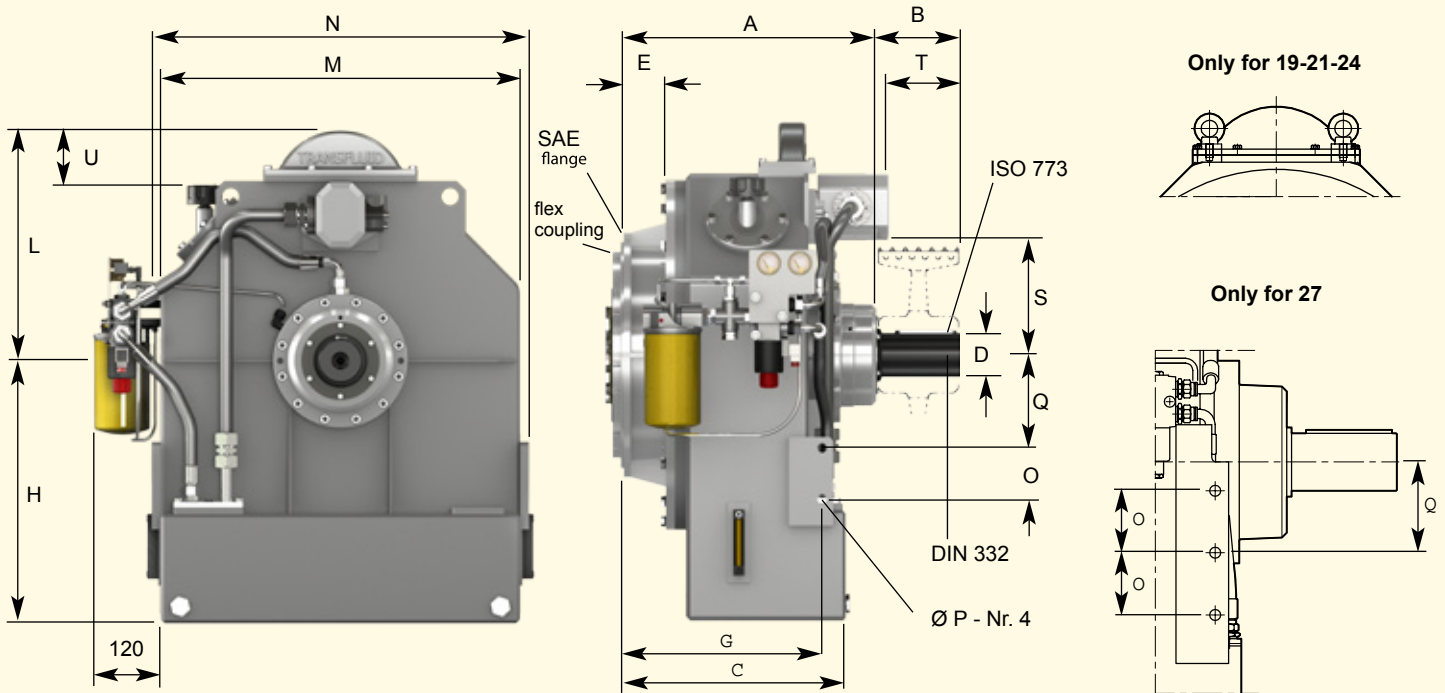

Size Dimensions

	A	B	C	D	E	G	H	L	M	N
15	414	130	430	70	61	362	440	395	560	590
19	455	150	450	80	98	406	500	420	670	700
21	517	180	512	100	105	458	600	480	820	860
24	583	180	502	100	95	448	600	526	820	860
27	710-726*	220	605-621*	120	123-139*	550-566*	675	445	890	940

Size Dimensions

	O	P	Q	S	T	U	SAE J617 housing	SAE J620 flywheel	Weight (kg) w/o oil	Oil (l)
15	65	17	135	205	66.5	115	2-1	11.5-14	250	28
19	80	19	155	228	68	85	1	14	310	35
21	115	21	210	260	87	115	1-0	14-18	475	65
24	115	21	210	260	163	70	1-0	14-18	550	65
27	130	23	190	-	-	-	0-00	18-21*	800	87

* Dimensions for flywheel 21".
For admissible radial loads apply Transfluid.

Dimensions can be changed without notice





















CRUSHER



MARINE PROPULSION

EUROPE

-  **AUSTRIA**
ASC GMBH
4470 Enns
-  **BELGIUM-LUXEMBURG**
TRANSFLUID FRANCE s.a.r.l.
38110 Rochetoirrin
Ph. +33 9 75635310
Fax +33 4 26007959
tfrance@transfluid.it
-  **CZECH REPUBLIC**
TESPO ENGINEERING s.r.o.
602 00 Brno
-  **DENMARK (Electric appl.)**
JENS S. TRANSMISSIONER A/S
DK 2635 ISHØJ
-  **ENGLAND & IRELAND**
MARINE AND INDUSTRIAL TRANS. LTD.
Queenborough Kent me11 5ee
-  **FINLAND (Electric appl.)**
OY JENS S. AB
02271 Espoo
-  **FINLAND (Diesel appl.)**
TRANS-AUTO AB
151 48 Södertälje (Sweden)
-  **FRANCE**
TRANSFLUID FRANCE s.a.r.l.
38110 Rochetoirrin
Ph. +33 9 75635310
Fax +33 4 26007959
tfrance@transfluid.it
-  **GERMANY**
TRANSFLUID GERMANY GmbH
D-48529 Nordhorn
Ph. +49 5921 7288808
Fax +49 5921 7288809
tfgermany@transfluid.it
-  **NORWAY (Diesel appl.)**
KGK Norge AS
0664 Oslo
-  **POLAND**
SENOMA LTD
PL40-153 Katowice
-  **PORTUGAL**
REDVARIO LDA
2735-469 Cacem
-  **RUSSIA - BELARUS - KAZAKHSTAN
UKRAINE**
TRANSFLUID OOO
143100 Moscow
Ph. +7 495 7782042
Mob. +7 926 8167357
tfrussia@transfluid.it
-  **SLOVENIA**
VIA INTERNATIONAL d.o.o.
1241 Kamnik
-  **SPAIN**
TECNOTRANS BONFIGLIOLI S.A.
08040 Barcelona
-  **SWEDEN (Electric appl.)**
JENS S. TRANSMISSIONER AB
SE-601-19 Norrköping
-  **SWEDEN (Diesel appl.)**
TRANS-AUTO AB
151 48 Södertälje
-  **THE NETHERLANDS**
TRANSFLUID GERMANY GmbH
D-48529 Nordhorn
Ph. +49 5921 7288808
Fax +49 5921 7288809
tfgermany@transfluid.it
-  **TURKEY**
REMAS
81700 Tuzla Istanbul

OCEANIA

-  **AUSTRALIA**
TRANSFLUID AUSTRALIA PTY LTD
Smithfield NSW 2164
Ph. +61 297572655
Fax +61 297560181
tfaustralia@transfluid.it
-  **NEW ZEALAND**
TRANSFLUID AUSTRALIA PTY LTD
Smithfield NSW 2164
Ph. +61 297572655
Fax +61 297560181
tfaustralia@transfluid.it



AMERICA

-  **ARGENTINA**
ACOTEC S.A.
Villa Adelina - Buenos Aires
-  **BRAZIL**
TRANSFLUID DO BRASIL
05014-060 Sao Paulo SP
Ph. +55 11 48235308
Fax +55 11 48235308
tfbrasil@transfluid.it
-  **SGI PTI**
04461-050 Sao Paulo SP
-  **CHILE**
SCEM LTDA
Santiago Do Chile
-  **COLUMBIA**
A.G.P. REPRESENTACIONES LTDA
77158 Bogotá
-  **PERU'**
SCEM LTDA SUC. PERU
LIMA 18
-  **U.S.A. - CANADA - MEXICO**
TRANSFLUID LLC
Auburn, GA30011
Ph. +1 770 822 1777
Fax +1 770 822 1774
tfusa@transfluid.it

AFRICA

-  **ALGERIA - CAMEROUN - GUINEA
MOROCCO - MAURITANIA -
SENEGAL - TUNISIA**
TRANSFLUID FRANCE s.a.r.l.
38110 Rochetoirrin (France)
Ph. +33 9 75635310
Fax +33 4 26007959
tfrance@transfluid.it
-  **EGYPT**
INTERN.FOR TRADING & AGENCY (ITACO)
Nasr City (Cairo)
-  **SOUTH AFRICA-SUB SAHARAN COUNTRIES**
BMG BEARING MAN GROUP
Johannesburg

ASIA

-  **ASIA South East**
ATRAN TRANSMISSION PTE LTD
Singapore 608 579
-  **CHINA**
TRANSFLUID BEIJING TRADE CO. LTD
101300 Beijing
Ph. +86 10 60442301-2
Fax +86 10 60442305
tbtinfo@sina.com
-  **INDIA**
PROTOS ENGINEERING CO. PRIVATE LTD
600002 Tamilnadu Chennai
-  **INDONESIA**
PT. HIMALAYA EVEREST JAYA
Barat Jakarta 11710
-  **IRAN**
LEBON CO.
Tehran 15166
-  **IRAN (Oil & Gas appl.)**
EVANPALA Inc
Tehran 1433643115
-  **ISRAEL**
ELRAM ENGINEERING &
ADVANCED TECHNOLOGIES 1992 LTD
Emek Hefer 38800
-  **JAPAN**
ASAHI SEIKO CO. LTD.
Osaka 593
-  **KOREA**
KIWON CORP.
Pusan - South Korea
-  **PHILIPPINES**
TRANSFLUID AUSTRALIA PTY LTD
Smithfield NSW 2164
Ph. +61 297572655
Fax +61 297560181
tfaustralia@transfluid.it
-  **TAIWAN**
FAIR POWER TECHNOLOGIES CO.LTD
105 Taipei
-  **THAILAND**
SYSTEM CORP. LTD.
Bangkok 10140
-  **UAE - SAUDI ARABIA - KUWAIT - OMAN
BAHRAIN - YEMEN - QATAR**
NICO INTERNATIONAL U.A.E.
Dubai

- ▲ TRANSFLUID SUBSIDIARIES
- ◆ REPRESENTATIVE OFFICE
- 🔧 SERVICE CENTER

Global web site: www.transfluid.eu

E-commerce web site: www.buy-transfluid.com

LOCAL DISTRIBUTOR